

GRILLES FOR VERANO TRENCH & CONVECTION UNITS

MDL: PROFESSIONAL GRADE HVAC SOLUTIONS



FRAMES FOR TRENCH HEATERS AND CLIMACONVECTORS

- Natural aluminum
- Anodized aluminum
- Painted aluminum



L-TYPE FRAME



F-TYPE FRAME

L AND F-TYPE FRAMES

FRAME DETAILS

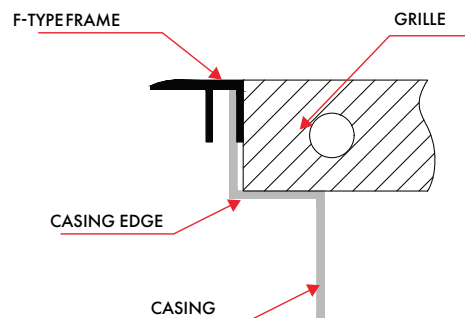
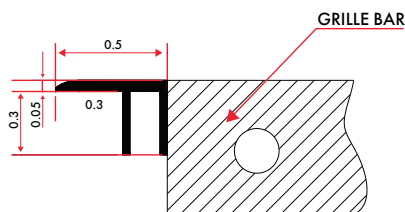
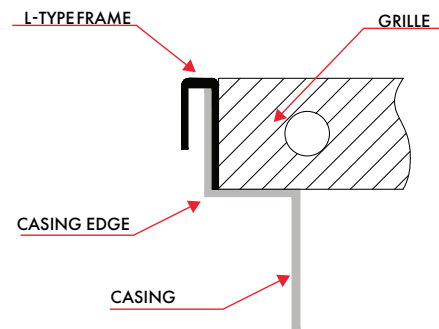
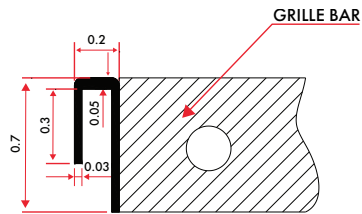

All grilles are optional accessories and not considered standard equipment for CVK, VKN or VK15 products. All images are for illustrative purposes only. Dimensions and offerings may vary, please contact a Verano by MDL sales representative for more information.

FRAME ASSEMBLY INSTRUCTION

The L-Type aluminum frame is a decorative element while the F-Type frame doubles as a masking element, hiding the space between the floor and the casing of any trench heater.

The frames are supplied in ready-cut elements for assembly.

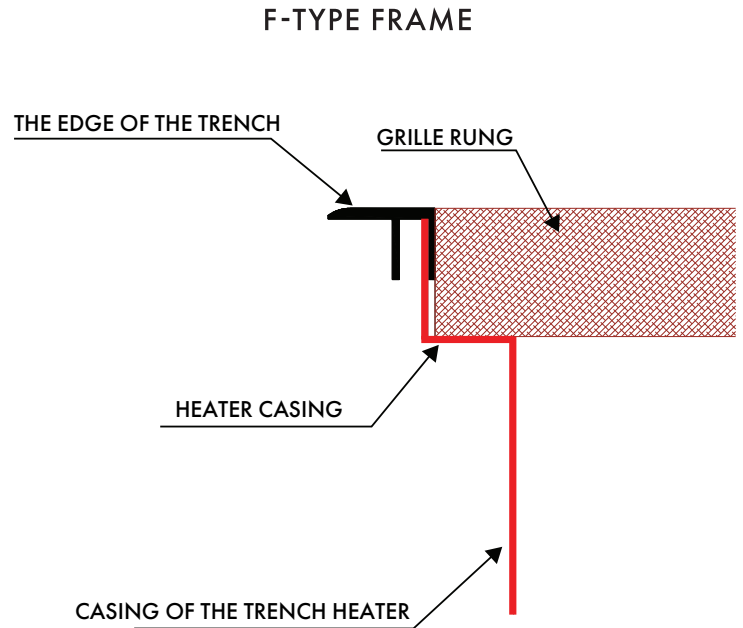
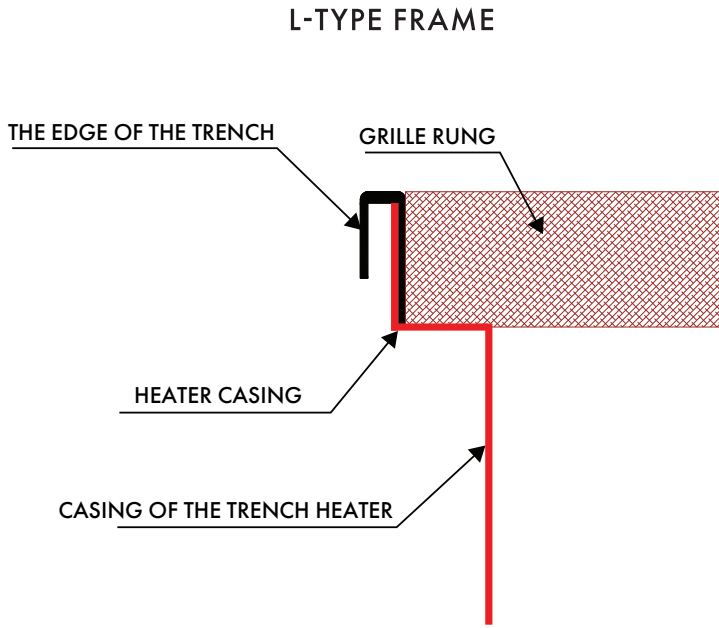

ANODIZED ALUMINUM COLOURS



SATIN 01



BLACK 05



STAINLESS STEEL
07



GOLD 00

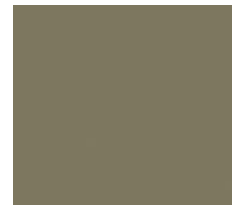

MEDIUM
BROWN 02

F AND L-FRAMES ARE AVAILABLE IN THE SAME ANODIZING COLOURS

RAL PALLETE

Frame and linear aluminum grilles are available in any RAL colour at additional surcharge.

DUMMY SECTION

The first step of heating and cooling unit selection is choosing the standard unit with the required heating and cooling output. However, sometimes the standard length of the unit does not match with the architectural vision of the room. For this kind of situation, we offer customized solutions, such as:

- Extension of the heater casing to the required length
- Producing separate dummy section

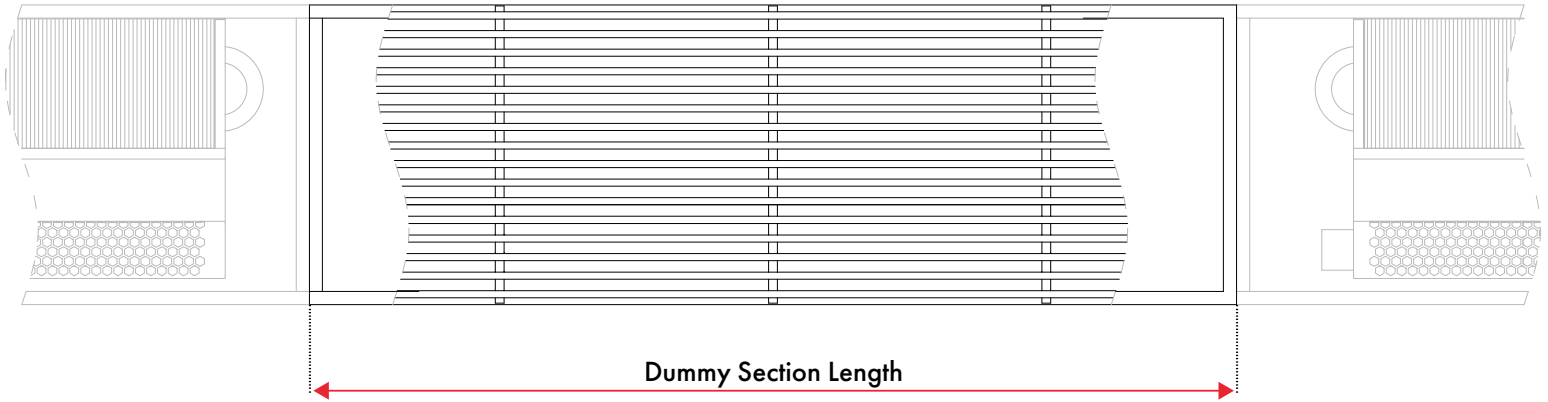

Separate dummy section is not compatible for heat exchanger or fan installation. Maximum dummy section length is 7.5 ft. Grilles and frames can be also customized.

CORNER TRENCH AND GRILLE OPTIONS



CORNER TRENCH WITH LINEAR GRILLE



CORNER TRENCH WITH CROSSBAR GRILLE



CORNER TRENCH WITH CROSS-BAR GRILLE
HERRINGBONE GRILLE SHAPE

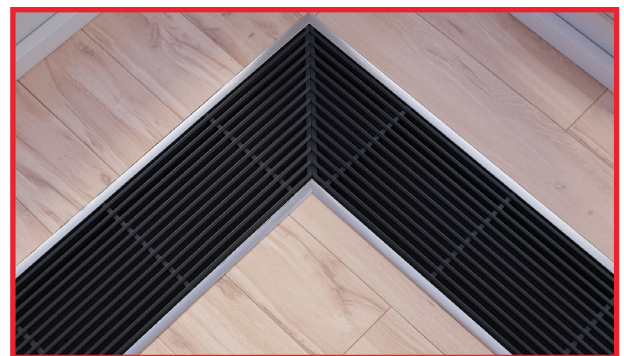

CORNER TRENCH WITH LINEAR GRILLE
HERRINGBONE GRILLE SHAPE

All grilles are optional accessories and not considered standard equipment for CVK, VKN or VK15 products. All images are for illustrative purposes only. Dimensions and offerings may vary, please contact a Verano by MDL sales representative for more information.

GRILLES

ROLL-UP DOUBLE T-BAR GRILLE

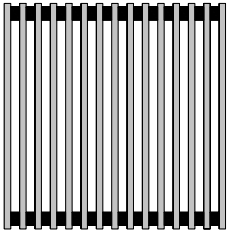

Top View



Single Bar
Cross Section

STANDARD: 0.5 in distances between bars, 0.4 in pitch. Maximum length of one grille section is 19.7 ft. Distances made of black plastic.

OPTIONAL: Distances are available in other colours 0.5-0.67 in pitch:

- Grey
- Beige
- Light brown
- Dark brown

GRILLE TYPE	COLOUR	ORDER CODE
DOUBLE T-BAR GRILLE NATURAL ALUMINUM	NATURAL ALUMINUM	ZDW
DOUBLE T-BAR GRILLE ANODIZED ALUMINUM	SATIN	ZADWS
	STAINLESS STEEL	ZADWST
	GOLD	ZADWZ
	BLACK	ZADWC

ROLL-UP GRILLE CLOSED PROFILE

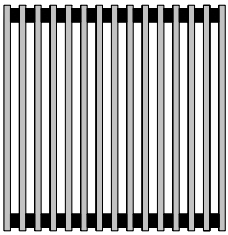

Top View



Single Bar
Cross Section

Cross bar roll-up grille made of closed profile aluminum bars.

Grille is available in:

- Natural aluminum
- Anodized aluminum

OPTION: Distances are available in other colours 0.67 in (0.67 in pitch):

- Grey
- Beige
- Light brown
- Dark brown

STANDARD: 0.5 in black plastic distances. 0.5 in pitch. Maximum length of one grille section is 19.7 ft.

	COLOUR	ORDER CODE
CLOSED PROFILE GRILLE NATURAL ALUMINUM	NATURAL ALUMINUM	ZAL
CLOSED PROFILE GRILLE ANODIZED ALUMINUM	SATIN	ZAALS
	STAINLESS STEEL	ZAALST
	GOLD	ZAAZL
	BLACK	ZAAALC

GRILLES

LINEAR GRILLE

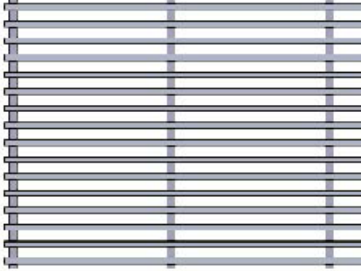

Grille made of aluminum.

Available as:

- Natural aluminum grille (transverse elements are powder coated in black RAL 9005)
- Anodized aluminum (transverse elements are powder coated in black RAL 9005)
- Grille powder coated in any RAL colour (additional surcharge)

It is possible to order options for angles other than 90°.



TOP VIEW

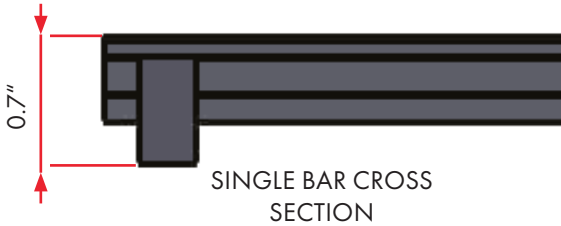

SINGLE BAR CROSS SECTION

GRILLE TYPE	COLOUR	ORDER CODE
LINEAR GRILLE, SNAP PROFILE - NATURAL ALUMINUM	NATURAL ALUMINUM	PZW
LINEAR GRILLE, SNAP PROFILE - ANODIZED ALUMINUM	SATIN	PZWAS
	STAINLESS STEEL	PZWAST
LINEAR GRILLE, SNAP PROFILE - ANY RAL COLOUR	ANY RAL COLOUR	PZWR

STAINLESS STEEL

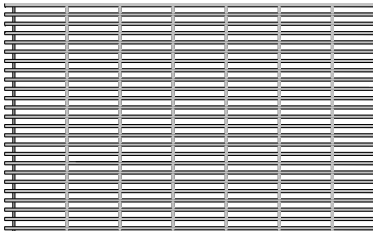

Linear rigid grille made of stainless steel.

Maximum length of one section is 6.5 ft.

Grilles ordered in sections longer than 6.5 ft will be delivered in sections.

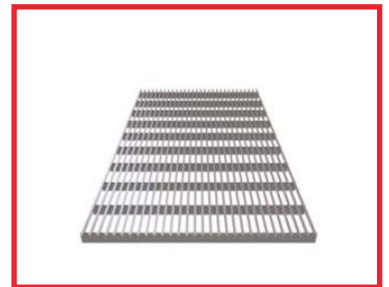

TOP VIEW



SINGLE BAR CROSS SECTION

GRILLE TYPE	COLOUR	ORDER CODE
STAINLESS STEEL GRILLE	STAINLESS STEEL	SN

All grilles are optional accessories and not considered standard equipment for CVK, VKN or VK15 products. All images are for illustrative purposes only. Dimensions and offerings may vary; please contact a Verano by MDL sales representative for more information.

ROLL-UP ALUMINUM GRILLE

Closed-profile aluminum grille

OPTIONS:

- Natural aluminum
- Aluminum painted in RAL
- Anodized aluminum

STANDARD:

Spacings (sleeves) between rungs as a standard are made of black PVC.

OPTIONAL:

- Spacings (sleeves) are also available in the following colors:
 - Gray WG-15
 - Beige W8-29
 - Light brown RAL 8256

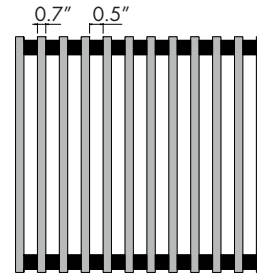

Top view

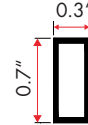

Cross-section of aluminum grille - profile closed

GRILLE TYPE	NAME OF GRILLE	ORDER CODE
ROLL-UP ALUMINUM GRILLE - PROFILE CLOSED	ROLL-UP NATURAL ALUMINUM GRILLE – PROFILE CLOSED	ZAL-1.8/W/L
	ROLL-UP PAINTED IN RAL ALUMINUM GRILLE – PROFILE CLOSED	ZRAL-1.8/W/L
	ROLL-UP ANODIZED ALUMINUM GRILLE – PROFILE CLOSED	ZAAL-1.8/W/L
	ROLL-UP WOOD IMITATION ALUMINUM GRILLE – PROFILE CLOSED	ZIAL-1.8/W/L

ROLL-UP ALUMINUM GRILLE – I-BEAM PROFILE

I-beam profile aluminum grille

OPTIONS:

- Natural aluminum
- Aluminum painted in RAL
- Anodized aluminum

STANDARD:

Spacings (sleeves) between rungs as a standard are made of black PVC.

OPTIONAL:

- Spacings (sleeves) are also available in the following colors:
 - Gray WG-15
 - Beige W8-29
 - Light brown RAL 8256
 - Dark brown RAL 8352

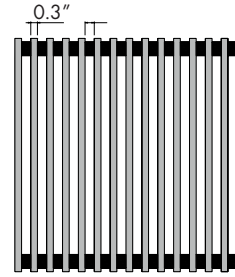

Top view

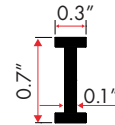

Cross-section of grille – I-beam profile



GRILLE TYPE	NAME OF GRILLE	ORDER CODE
ROLL-UP ALUMINUM GRILLE – I BEAM PROFILE	ROLL-UP NATURAL ALUMINUM GRILLE – I-BEAM PROFILE	ZDW-1.8/W/L
	ROLL-UP PAINTED IN RAL ALUMINUM GRILLE – I-BEAM PROFILE	ZRDW-1.8/W/L
	ROLL-UP ANODIZED ALUMINUM GRILLE – I-BEAM PROFILE	ZADW-1.8/W/L

LINEAR ALUMINUM GRILLE

Closed profile aluminum grille.

The grille is completely made of aluminum.

The grille is only available in RAL colours.

Standard colour is black RAL 9005.



Top view

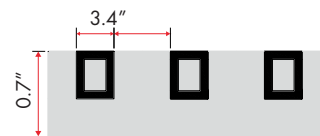

Cross-section of linear grille painted in RAL



GRILLE TYPE	NAME OF GRILLE	ORDER CODE
LINEAR GRILLE	LINEAR PAINTED IN RAL ALUMINUM GRILLE – PROFILE CLOSED	ALWR-1,8/W/L

MODULAR ALUMINUM GRILLE

The grille is made of aluminum.

OPTIONS:

Natural aluminum

- Aluminum painted in RAL
- Anodized aluminum

Spacings (rung fasteners) are made of black plastic.

The length of single module is 1.4 ft.

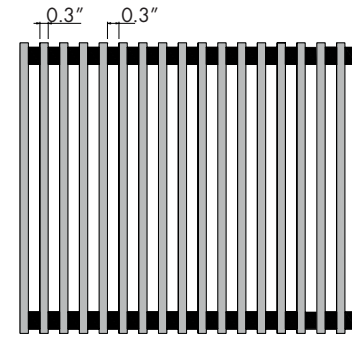

Top View



GRILLE TYPE	NAME OF GRILLE	ORDER CODE
MODULAR ALUMINUM GRILLE – PROFILE CLOSED	MODULAR NATURAL ALUMINUM GRILLE – PROFILE CLOSED	MAL-1.8/W/L
	MODULAR PAINTED IN RAL ALUMINUM GRILLE – PROFILE CLOSED	MRAL-1.8/W/L
	MODULAR ANODIZED ALUMINUM GRILLE – PROFILE CLOSED	MAAL-1.8/W/L
	MODULAR WOOD IMITATION ALUMINUM GRILLE – PROFILE CLOSED	MIAL-1.8/W/L

LINEAR STAINLESS STEEL GRILLE

The grille is available only as a rigid version.

The maximum length of one section of the grill is 6.5 ft.

Grille length longer than 6.5 ft are made of several elements of equal lengths.

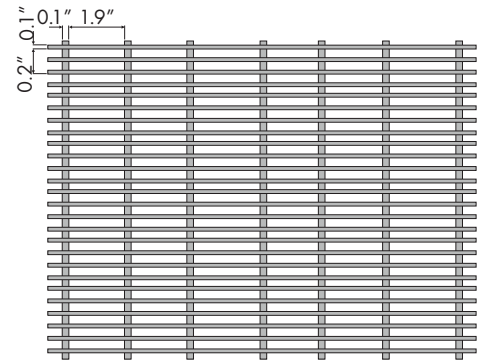

Top View

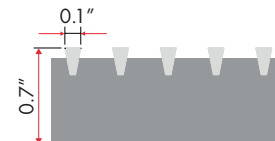

Cross-section of stainless steel grille

GRILLE TYPE	NAME OF GRILLE	ORDER CODE
STAINLESS STEEL GRILLE	LINEAR STAINLESS STEEL GRILLE	SN-1,8/W/L

All grilles are optional accessories and not considered standard equipment for CVK, VKN or VK15 products. All images are for illustrative purposes only. Dimensions and offerings may vary, please contact a Verano by MDL sales representative for more information.

VERANO[®]

BY MDL SOLUTIONS

COMPACT LOWER VOLTAGE FAN COILS AND HYDRONIC HEAT | MDLSOLN.COM

The data presented in this document is correct at time of publication. Illustrations may include optional accessories. Due to continuous research and development, and the desire to improve the quality of our products, MDL Solutions reserves the right to make changes regarding design and specifications without prior notice.